

LA-1678

0.3



UNCLASSIFIED

CIC-14 REPORT COLLECTION
REPRODUCTION
COPY

LOS ALAMOS SCIENTIFIC LABORATORY

OF THE

UNIVERSITY OF CALIFORNIA

CONTRACT W-7405-ENG. 36 WITH

U. S. ATOMIC ENERGY COMMISSION

LOS ALAMOS NATIONAL LABORATORY



3 9338 00407 2566

UNCLASSIFIED





UNCLASSIFIED

PUBLICLY RELEASABLE
LANL Classification Group
[Signature]
10/19/95

LOS ALAMOS SCIENTIFIC LABORATORY
of the
UNIVERSITY OF CALIFORNIA

Report written:
May 1954

Report distributed: AUG 19 1954

LA-1678

A PORTABLE APPARATUS FOR THE
DETERMINATION OF TRITIUM IN LIQUID SAMPLES

Work done by:

B. C. Eutsler
M. F. Milligan
W. E. Wilson

Classification changed to UNCLASSIFIED
by authority of the U. S. Atomic Energy Commission
Per *J. C. [Signature]* 11-11-36
By *J. C. [Signature]* 11-19-56
REPORT LIBRARY

Report written by:

Jean McClelland

INSTRUMENTATION



UNCLASSIFIED

UNCLASSIFIED

ABSTRACT

A glass vacuum manifold and ionization chamber are evacuated and filled to atmospheric pressure with hydrogen and tritium. The hydrogen and tritium are evolved by dropping liquid, urine or water, on calcium metal and dried by passing through a suitable freezing bath. The current produced by the beta activity due to tritium is measured with a vibrating reed electrometer. The method has a precision of ± 3 per cent between the ranges of 100 and 1500 μc of tritium per liter. From 0 to 100 μc of tritium per liter the precision is ± 5 to 10 per cent.

The glass vacuum manifold has been constructed to fit in an aluminum suitcase which contains all the auxiliary equipment for the determination except the vacuum pump, vibrating reed electrometer, and the freezing bath solutions. The apparatus is sturdy and readily transported. The procedure is simple and adapted for use by untrained personnel.

UNCLASSIFIED

UNCLASSIFIED

1. Introduction

Health monitoring operations at LASL necessitated the development of a portable or semi-portable apparatus for the determination of tritium in urine and water. The apparatus used in the laboratory for generating tritium for direct beta counting is too cumbersome and fragile to be readily transported.¹ A simplified determination which could be carried out in the field with a minimum of sturdy, readily transported apparatus and little auxiliary equipment was necessary.

The electrometric method of measurement was chosen since a simpler and more compact apparatus could be used to generate a single gas at atmospheric pressure than one which necessitated filling tubes at partial pressures with the three gases used for beta counting. A small glass vacuum manifold was constructed to fit in an aluminum suitcase. All the necessary equipment was fitted in the case except the vacuum pump, freezing agents, and the vibrating reed electrometer. These items were not included in the packing plan since they were available in the field.

The method is simple and can be easily carried out by untrained personnel. The glass manifold and ionization chamber are evacuated, the liquid is dropped on calcium metal, and the hydrogen and tritium evolved are dried by passing through a freezing bath. When the gas in the system has attained atmospheric pressure the ionization chamber is removed and the ionization current produced by the beta particles is measured with a vibrating reed electrometer.² The tritium concentration is directly proportional to the current measured.

2. Experimental

The gas evolved was dried by passing it through liquid nitrogen since the nitrogen was available for field operations. A brief study was made of the effect of drying at higher temperatures with two other freezing baths; salt and ice, and alcohol and dry ice.

TABLE I
EFFECT OF GAS DRYING TEMPERATURES

127 μ c tritium/liter of solution	Scale readings, mv		
	1* Liquid nitrogen -195°C	2 CH ₃ OH + CO ₂ -78°C	3 Ice + salt -12°C
1	8.5	10	10
2	8.8	11	11
3	8.8	11	12
4	9.2	10	12

*Measurements with liquid nitrogen were made with a different electrometer than those of No. 2 and No. 3,

UNCLASSIFIED

[REDACTED]

The data (Table I) indicate that the freezing bath used has little effect on the reproducibility. It is evident that any solution which will condense and freeze the water vapor from the gas may be used. A desiccant might be satisfactory if changes were made in the manifold design.

A few determinations were made using an aspirator to evacuate the system instead of a vacuum pump. With the partial vacuum obtained with an aspirator, residual gas was left in the chamber which gave erratic results. Repeated flushing with air before filling did not increase the reproducibility.

Standard curves made with several vibrating reed electrometers using different freezing baths show little deviation. However, the authors recommend that standards and samples be determined with the same conditions. The standard curve should be checked for each new instrument and each time the resistor on the electrometer head is changed. It is advisable to check the curve whenever the instrument is repaired. The calibration is constant for all ionization chambers having the same volume.

The determination of urine and water samples containing known amounts of tritium indicate that the method has a precision of ± 3 per cent between the ranges of 100 and 1500 μc of tritium per liter and a precision between ± 5 per cent and 10 per cent from 0 to 100 μc of tritium per liter of sample.

3. Procedure

Reagents

Metallic Calcium - No. 10 mesh. The calcium used is a specially purified calcium obtained from the Chemistry and Metallurgy Division, LASL.

Mercury

Liquid Nitrogen

Apiezon M Stopcock Grease

Dow-Corning High Vacuum Grease - A silicone lubricant.

Dow-Corning Antifoam A - A silicone defoamer.

Alconox - A detergent.

Kerosene - A degreasing agent.

Distilled Water

Tritium Standard - The stock standard is water containing tritium oxide obtained from the Chemistry and Metallurgy Division, LASL. The standard contains 200 μc of tritium per liter as of April 1, 1954.

Apparatus

Glass Vacuum Manifold - Figure 1.

Glass Generator - Figure 2.

Vacuum Pump - Cenco Hyvac or Welch Duoseal, 1/3 HP, with pressure tubing and 18/7 male semiball joint.

Dewar Vessel - 500 ml.

Ionization Chamber - 250 ml Borkowski type, supplied by the manufacturer of the electrometer.

Model 30 Vibrating Reed Electrometer - Applied Physics Corporation, Pasadena, Calif.

3.1 Preparing the Vacuum System for Use

1. Remove the mounting board with the glass manifold from the suitcase and mount it on a suitable rack or stand. The stopcocks and joints on the vacuum system (manifold) should be greased periodically with Dow-Corning High Vacuum grease.

2. Fill the glass manometer with mercury, using a small funnel, to a depth of approximately 35 cm on the meter stick which is fastened behind the manometer. Attach the manometer to the glass stubs (marked manometer) on the manifold with short pieces of 1/4-in. ID Tygon tubing.

3. Attach the pressure tubing to the vacuum pump and insert the short piece of glass tubing with the 18/7 male semiball joint in the other end of the tubing. Secure the tubing at the pump and at the joint with wire. Grease the male joint, attach, and clamp to the 18/7 female semiball joint on the left side of the manifold.

4. Connect the condenser on the left side of the manifold to a cold water inlet and outlet with Tygon tubing.

5. Close stopcocks No. 1, No. 5, and No. 6. Open stopcocks No. 2, No. 3, and No. 4. Grease the joint on the tubular freezing trap (a generator bottom) with Dow-Corning High Vacuum grease and place on the 55/50 joint. Evacuate the system completely and close stopcock No. 4. The manometer is used as a closed-end manometer and stopcock No. 4 is left closed unless air leaks into the left arm of the manometer. After evacuation open the system to the atmosphere and mark the meter stick at the mercury level of the left arm.

6. Place approximately 2 to 3 g of metallic calcium in the bottom of the glass generator. Ring the lower section of the generator with Dow-Corning Antifoam A. Grease the stopcock on the generator top with Apiezon M stopcock grease and put in place. Seal the top of the generator to the bottom with Apiezon M grease. Grease the 18/7 male joint on the left of the manifold and fit the generator to it. Clamp the joint. Open the three-way stopcock, No. 1, between the vacuum line and the generator.

7. Partially fill the dewar vessel with liquid nitrogen and place around the trap on the vacuum line. Add more liquid nitrogen to fill the dewar. The dewar should be kept full during the operation of the system.

8. Place the ionization chamber in the 12/20 female joint on the right side of the manifold. Open the stopcock of the chamber to the line. Open stopcock No. 5 between the vacuum line and the chamber.

9. Close stopcock No. 6, open stopcock No. 2 and No. 3, and start the vacuum pump. Evacuate the system until the mercury arms on the manometer are level. The vacuum pump will have a smooth regular sound when the system is evacuated.

3.2 Generating the Sample

1. Fill the thistle tube on the generator with the liquid sample. The thistle tube holds approximately 30 ml of sample. If an air bubble appears in the thistle tube it may be teased out with a piece of wire.

2. Close stopcock No. 2 to the vacuum pump.

3. Carefully drop the sample on the metallic calcium until the mercury pressure shown on the manometer is slightly above (0.5 to 1 cm) the atmospheric pressure mark.

4. Quickly close stopcock No. 3 and open the three-way stopcock No. 1 to the atmosphere. Remove the generator from the line, remove the top and flood the bottom of the generator with water.

5. Carefully bleed off the gas in excess of atmospheric pressure with stopcock No. 6. Close the stopcock on the ionization chamber and remove the chamber from the line.

3.3 Shutting Down the Apparatus

1. Open stopcocks No. 2 and 5 to vent the line to the atmosphere.

2. Shut off the vacuum pump.

3. Remove the dewar vessel from the trap and empty the liquid nitrogen. Remove the trap from the vacuum line. Let thaw, drain and dry.

4. Wash the generators by rinsing out the spent calcium with water. Soak the top and bottom in kerosene for several hours to remove the Apiezon grease. Scrub the generators with Alconox and water. Rinse well and dry in an oven. The generators must be thoroughly dry before use to prevent reaction with the calcium metal.

[REDACTED]

4. Operating Instructions for the Vibrating Reed Electrometer,
Model 30, Applied Physics Corporation (Figure 3)

4.1 Instrument Warm-up

1. Plug the power cord on the amplifier cabinet into a 115-volt, 50/60-cycle line. Connect the input terminal to the electrometer head and the amplifier cabinet. The operator should have the Instruction Manual,³ supplied by the manufacturers, available at all times. The electrometer head should be closed with the dust cap and a high-value resistor (10^{12} ohms) should be in place and connected to post "G" on the head (Figs. 4 and 5).

2. Make certain that the shorting switch on the electrometer head is closed (the "in" position). Turn the range switch to the 1000-mv position and place the power switch in the "on" position.

3. Move the meter reversal switch from the center position ("off") to the + or - position, leaving it in the position which causes the needle on the panel meter to deflect up scale. The position of this switch indicates the polarity of the charge on the input terminal of the instrument. The older type Model 30 does not have this switch and this step is omitted when using it.

4. Move the zero adjustment polarity switch from the center position ("off") to either the + or - position and position the "zero" knob until the meter reads approximately zero. If one cannot zero the meter needle with the "zero" knob, reverse the polarity of the zero adjustment polarity switch and again zero the instrument with the "zero" knob.

5. Let the instrument warm for at least 20 minutes for minimum drift. If the instrument is in daily or frequent use it may be left on continuously.

4.2 Reading Samples

1. Check to be sure that the shorting switch on the electrometer head is closed. Remove dust caps from the electrometer head and from the ionization chamber. Attach the ionization chamber (Borkowski-type ionization chamber, 250-ml volume) (Fig. 6) rigidly to the electrometer head by means of the three thumbscrews. Make certain that the spring connector in the input terminal makes connection to the collector electrode of the ionization chamber.

Connect the terminal post on the ionization chamber to the negative terminal of the polarizing battery (a 45-volt "B" battery). Connect the positive post of the battery to terminal post "F" on the electrometer head. This polarity may be reversed but it is advisable to be consistent--chamber backgrounds, calibrations, and samples should be read with the same polarity.

2. With the range switch in the 1000-mv position check the polarity again with the meter reversal switch--the needle deflects up scale when the polarity of the charge on the input terminal

corresponds to the position of the meter reversal switch. If the battery is connected as described, the switch should be in the negative position. Position the "zero" knob until the meter needle reads approximately zero.

3. Move the range switch to the 100-mv position and position the "zero" knob until the meter reads approximately zero.* Repeat with the 10-mv position and the 1-mv position. Zero the meter needle exactly in the 1-mv position.

4. Allow the instrument to warm up until the rate of drift of the meter needle is negligible.

5. When the drift rate is stable turn the range switch to the 1000-mv position and open the shorting switch on the electrometer head. After the meter needle stops drifting* note the reading of the needle on the scale. If the scale reading is less than 0.1 turn the range switch to the 100-mv position and similarly to the 10-mv position. If the scale reading is still less than 0.1 turn the range switch to the 1-mv position and note the reading. When a reading is obtained record the scale reading and the millivolt range used. Readings may be checked by using the next decade range above or below.

The 1000-mv range represents 10^{-12} amperes full scale when a 10^{12} -ohm resistor is used. The range decreases by powers of ten so that the 1-mv range is equivalent to 10^{-15} amperes. For currents between 10^{-15} and 10^{-12} amperes, readings on the scale are taken directly. If the current measured is less than 10^{-15} amperes, readings must be made by the drift-rate method described in the Instruction Manual.³ Currents of such small magnitude are not significant in this determination. With the chamber filling used in this method readings in the 1-mv range are difficult to make on some instruments due to drift.

6. From a standard curve (Fig. 7) find the microcuries of tritium per liter corresponding to the scale reading and multiply by the factor given for the range used. Subtract the ionization chamber background in microcuries of tritium per liter. If the range used is 10 mv or greater the background is not significant. The results are reported as microcuries of tritium per liter of sample.

7. Turn the range switch to the 1000-mv position, closing the shorting switch, disconnect the battery connection from the ionization chamber, and remove the chamber from the electrometer head. Immediately replace the dust caps on the electrometer head and on the ionization chamber. Move the zero adjustment polarity switch and the meter reversal switch to the "off" (center) position.

8. When operations are finished turn off the power switch.

*The instrument has a considerable time lag and the operator must wait until the needle steadies before zeroing the instrument or taking readings.

5. Calibration5.1 Ionization Chamber Background

Fill the ionization chamber with inert hydrogen generated from distilled water as given in Section 3.2, "Generating the Sample," and read the current as given in Section 4, on "Operating the Vibrating Reed Electrometer." The scale reading obtained is converted to microcuries of tritium per liter from the standard curve and is the ionization current background for that chamber. A background must be run for each chamber used. The backgrounds remain quite constant but should be checked every few weeks.

If the chamber background is greater than 1 μc of tritium per liter, the chamber should be cleaned. A high background may be due to dirt or to tritium adsorbed on the walls of the chamber. Backgrounds can usually be maintained at this level by simply evacuating the chamber and flushing with air. If this does not bring down the background, unscrew the collector electrode assembly and wash the chamber with soap and water. Rinse thoroughly with distilled water and bake the metal parts of the chamber. In some cases it may be necessary to replace the insulator and gaskets. Flush the chamber several times with inert gas and repeat the background.

5.2 Preparation of the Standard Curve

The net current (observed current minus the chamber background) is proportional to the tritium content of the sample. Fill the ionization chamber with tritium generated from standard tritium solutions containing 50, 100, 150, and 200 μc of tritium per liter. Generate the standards using the procedure given in Section 3.2, "Generating the Sample," and measure the current as given in Section 4, "Operating Instructions for the Vibrating Reed Electrometer." The scale reading is plotted versus the concentration of tritium in microcuries per liter divided by the millivolt range used (1, 10, 100, or 1000). This gives a standard curve similar to Fig. 7.

This standard curve can be used for any Borkowski type ionization chamber having the same volume--in this case 250 ml. A new standard curve must be prepared if a change is made in the volume of the chambers, if a different resistor is installed on the electrometer head, or if the milliammeter scale is changed on the amplifier. A calibration curve should be made for each vibrating reed electrometer used. The curve should be checked after the instrument has been repaired or recalibrated and at different atmospheric pressures.

ACKNOWLEDGMENT

The author wishes to acknowledge the work of John H. Larkins, Group H-4, who assisted with the section on the vibrating reed electrometer.

References

1. Jean McClelland and M. F. Milligan, "The Determination of Tritium in Urine and Water," Los Alamos Scientific Laboratory Report LA-1645, April 1954.
2. K. E. Wilzbach, A. R. Van Dyken, and Louis Kaplan, Argonne National Laboratory Report ANL 5143, October 1953.
3. "Instruction Manual for Vibrating Reed Electrometer", Applied Physics Corporation, 362 West Colorado Street, Pasadena 1, Calif.

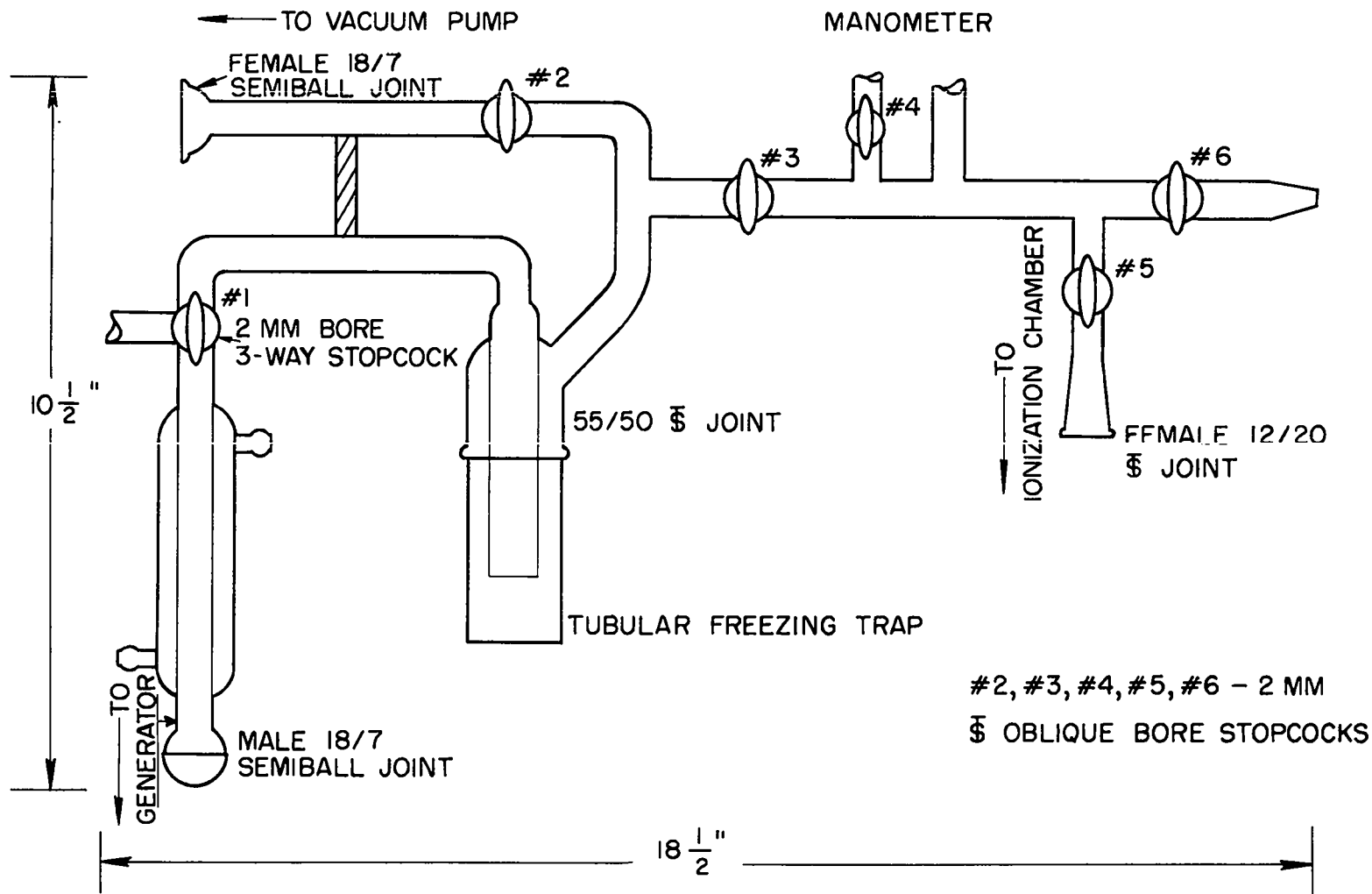

Fig. 1 Glass manifold for filling chambers.

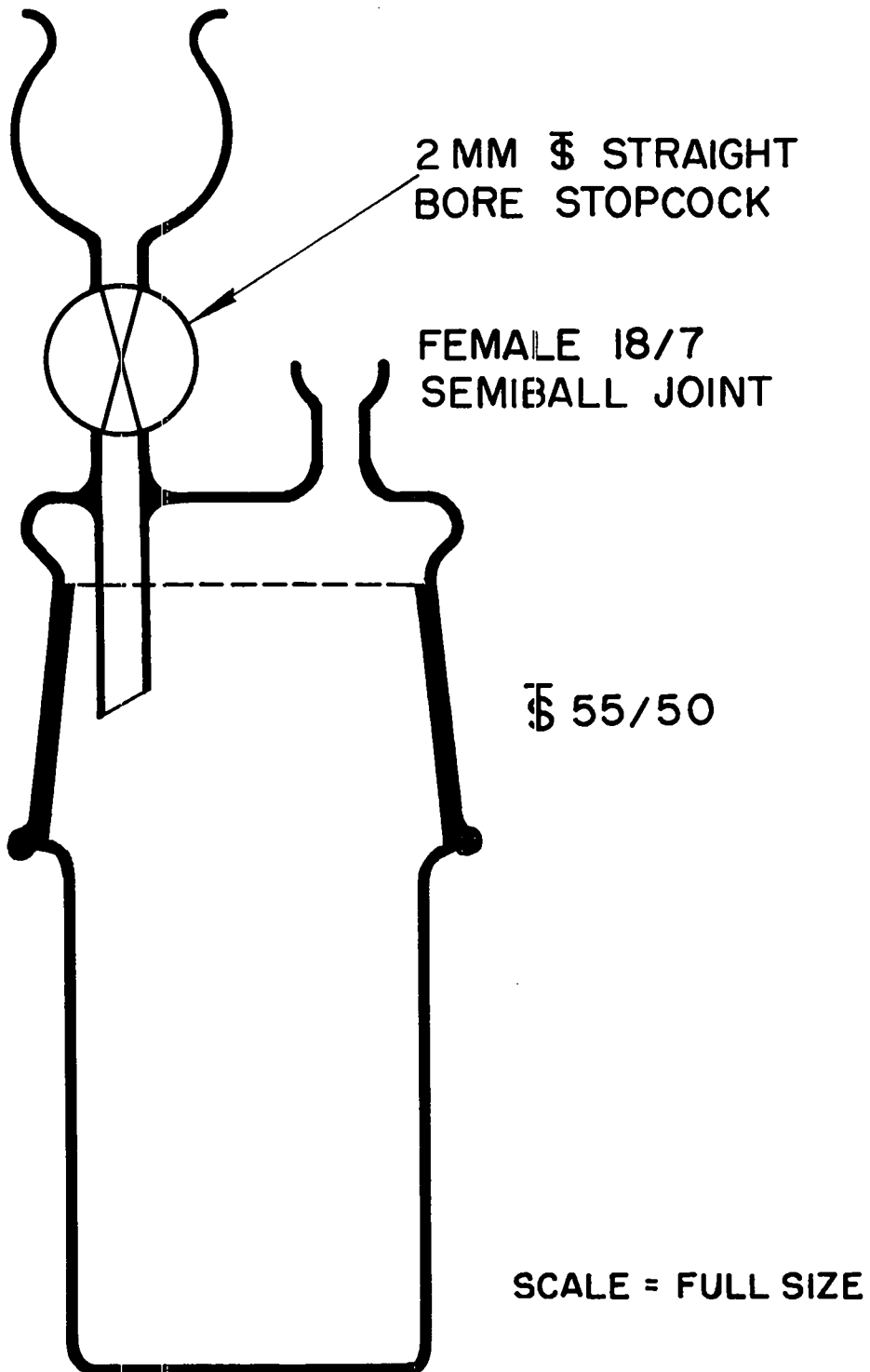

Fig. 2 Cross section of generator flask.



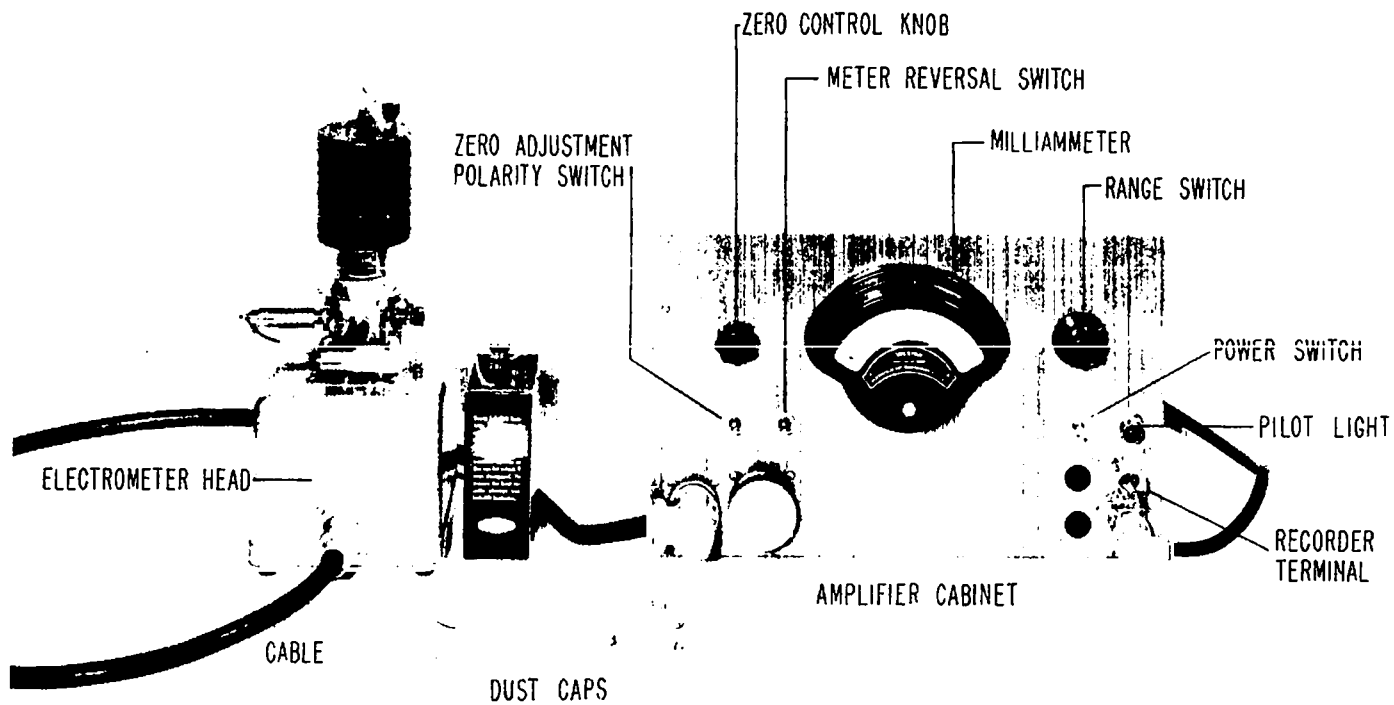

Fig. 3 Vibrating reed amplifier and electrometer head.

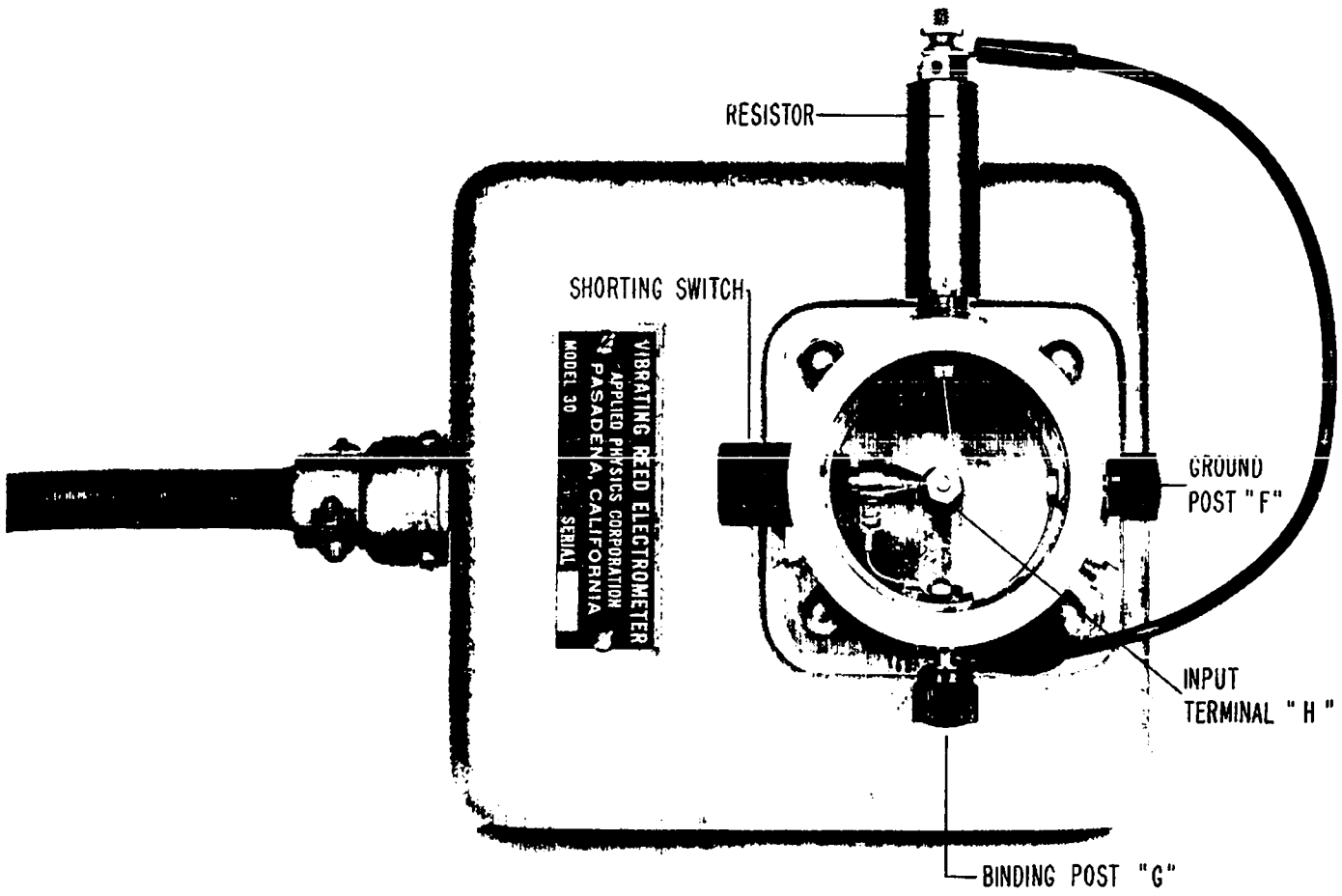

Fig. 4 Topview of the electrometer head.

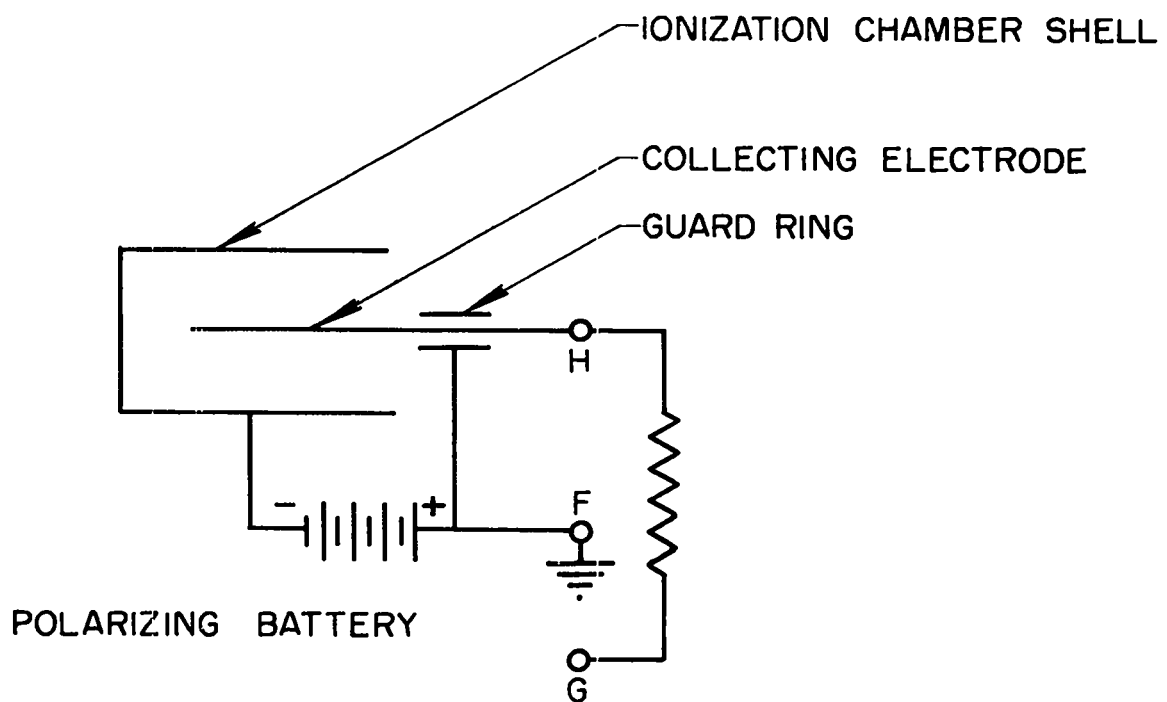

Fig. 5 Diagram of connections to the ionization chamber.

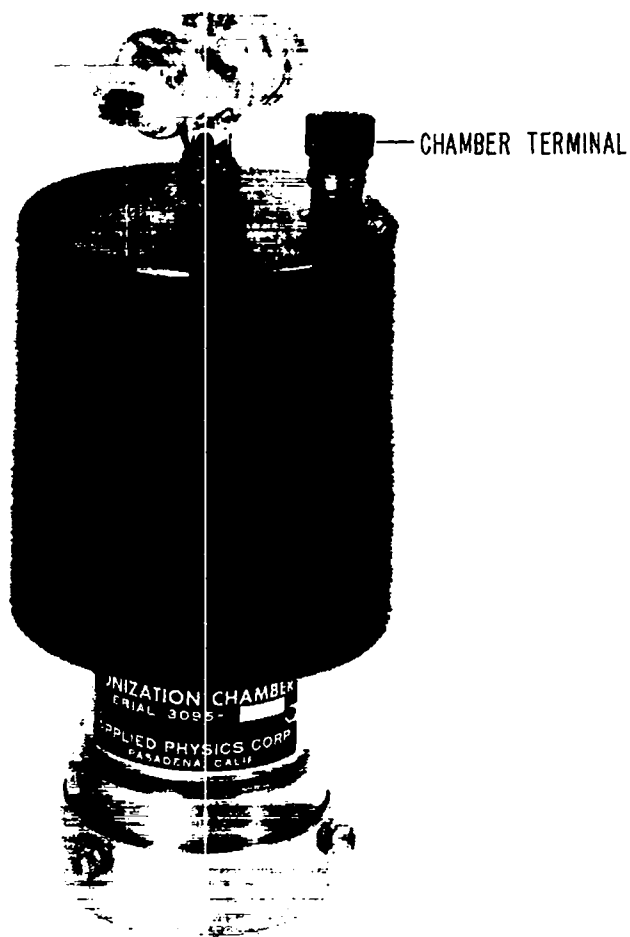

Fig. 6 Borkowski-type ionization chamber.

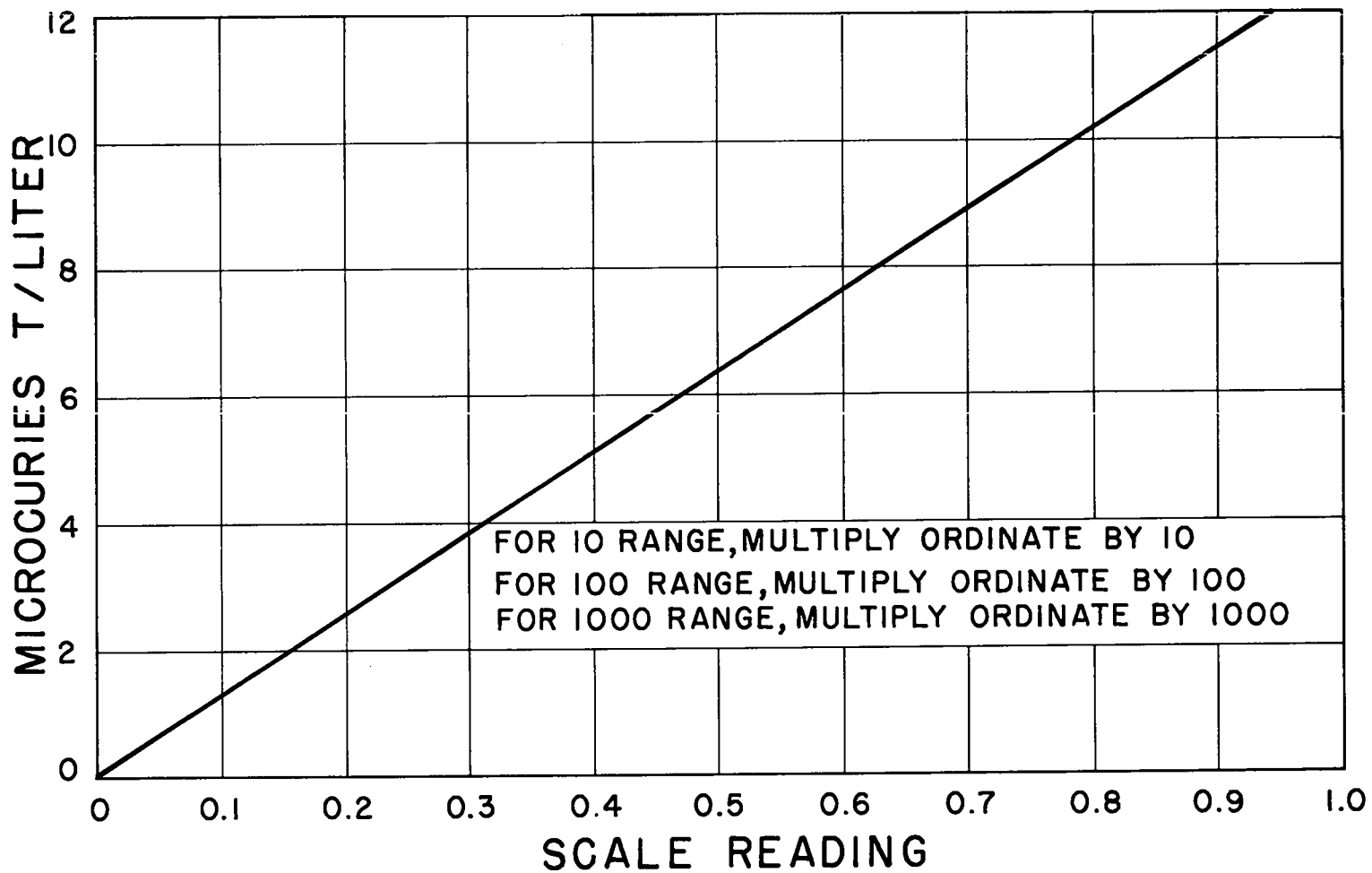

Fig. 7 Standard curve for tritium at an atmospheric pressure of 590 mm of mercury

Appendix AEquipment in Suitcase

The suitcase is a Halliburton Company aluminum Model 110X (Los Angeles). The packed suitcase shown in Fig. 8 contains an earlier model glass vacuum manifold than the one described in this report.

Contents

1 glass vacuum manifold	1 5-oz jar Apiezon M Stopcock Grease
1 mounting board	3 ft rubber tubing, 3/4-in. ID x 1/4-in. thickness
6 glass generators	1 male 18/7 semiball joint
2 Borkowski-type ionization chambers, 250 ml.	1 dewar vessel, 500 ml
1 U-tube, pyrex, 7-mm OD, with 29-in. arms (the manometer)*	2 micro-precision pinch clamps for spherical joints, No. 18
1 meter stick, 75 cm (wired behind the U-tube)	4 4-oz bottles metallic calcium
10 ft Tygon tubing, 1/4-in. ID	1 4-oz can Dow-Corning Anti-Foam A
1 2-oz bottle mercury	1 screw driver
1 25-mm micro-funnel	1 5-in. file
1 2-oz jar Dow-Corning High Vacuum Grease	4 oz standard tritium solution, 200 μ c tritium/liter

*The manometer used with the present manifold is detachable and is packed diagonally in the suitcase with the meter stick.



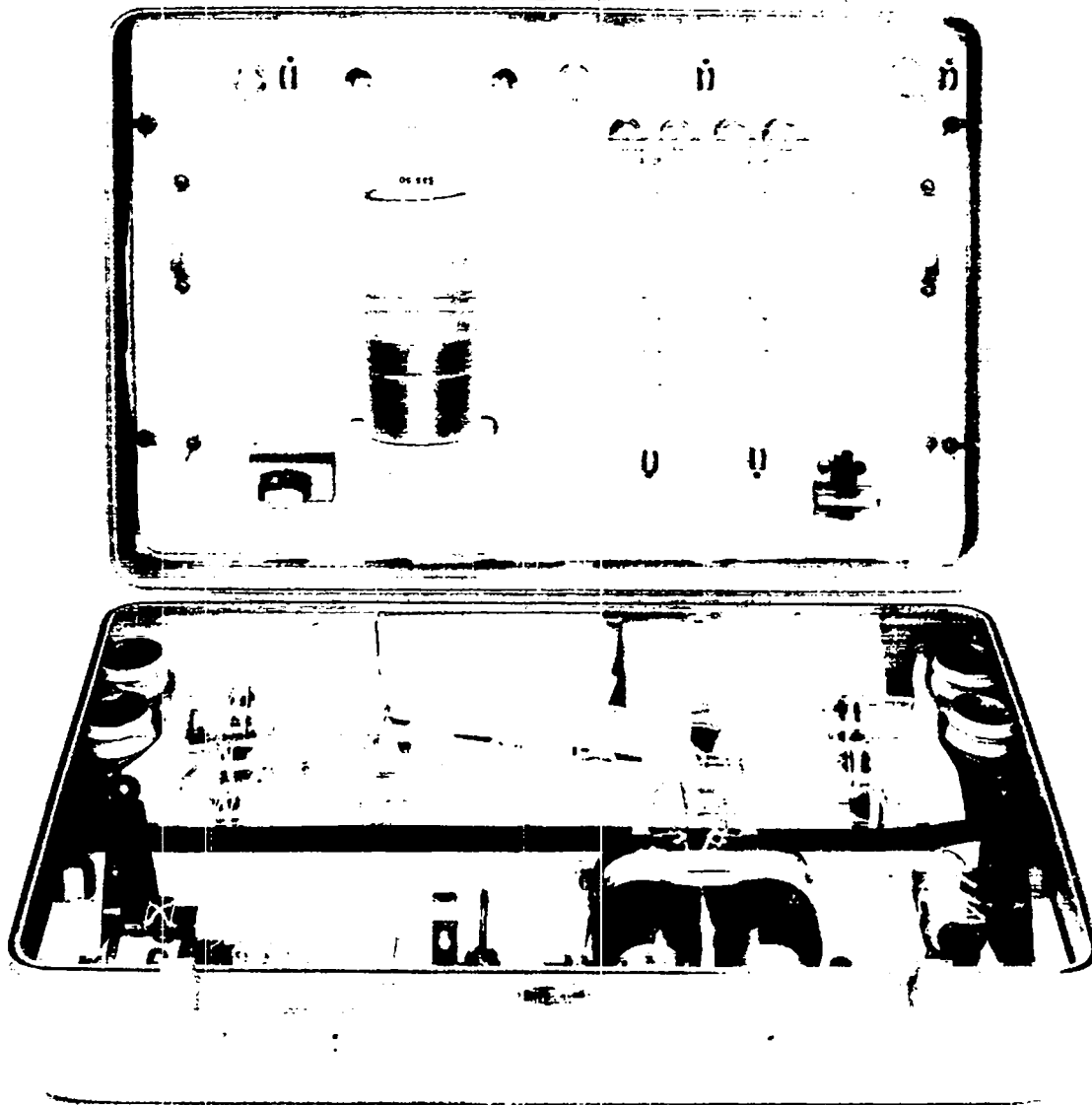

Fig. 8 Suitcase packed for shipment.

.

SECRET

AUG 19 1954

.

SECRET